

IEC Appliance Inlet C14 with Filter, very high attenuation, ECO design, Screw- or Snap-in Mounting



See below:  
[Approvals and Compliances](#)

### Description

- Compact IEC C14 Appliance Inlet with Filter
- Snap-in or screw-on mounting
- Appliance Inlet Protection class I ,
- Line filter in standard and medical version

### Unique Selling Proposition

- Very high attenuation
- V-Lock cord retaining
- Metal flange for optimal shielding
- Compact design

### Characteristics

- Compact filter with very high attenuation
- Optimal shielding due to completely closed filter case, unpotted
- Ideal for application with high disturbance level
- Suitable for applications according IEC/UL 62368-1
- Suitable for use in medical equipment according to IEC/UL 60601-1 (1 MOOP, 1 MOPP)

### Other versions on request

- Snap-in for panel thickness >2mm to 3mm
- flexible wire with various lengths
- Class X1- and Y1-capacitors for enhanced withstand voltage
- Variant with metal flange for front or rear mounting

### Weblinks

[pdf data sheet](#), [html datasheet](#), [General Product Information](#), [Approvals](#), [Distributor-Stock-Check](#), [Accessories](#), [Detailed request for product](#)

### Technical Data

Ratings IEC	1 - 10A @ Ta 40 °C / 250VAC; 50Hz	Appliance inlet/-outlet	C14 acc. to IEC 60320-1, UL 498, CSA C22.2 no. 42 (for cold conditions) pin-temperature 70 °C, 10A, Protection Class I
Ratings UL/CSA	1 - 15A @ Ta 40 °C / 250VAC; 60Hz	Line Filter	Standard and Medical Version, IEC 60939, UL 60939-3, CSA C22.2 no. 8 <a href="#">Technical Details</a>
Leakage Current	standard < 0.5mA (250V / 60Hz) medical < 5 µA (250 V / 60 Hz)	MTBF	> 3'000'000h acc. to MIL-HB-217 F
Dielectric Strength	> 1.7kVDC between L-N > 2.7kVDC between L/N-PE Test voltage (2 sec)		
Allowable Operation Temperature	-25 °C to 85 °C		
Climatic Category	25/085/21 acc. to IEC 60068-1		
IP-Protection	front side IP40 acc. to IEC 60529		
Protection Class	Suitable for appliances with protection class I acc. to IEC 61140		
Terminal	Quick connect terminals 6.3 x 0.8 mm		
Panel Thickness S	Screw: max 8mm Mounting screw torque max 0.5Nm Snap-in: 0.8mm to 2mm (all steps with one variant)		
Material	Themoplast / steel tin-plated, black / metallic, UL 94V-0		

### Approvals and Compliances



Detailed information on product approvals, code requirements, usage instructions and detailed test conditions can be looked up in [Details about Approvals](#)

SCHURTER products are designed for use in industrial environments. They have approvals from independent testing bodies according to national and international standards. Products with specific characteristics and requirements such as required in the automotive sector according to IATF 16949, medical technology according to ISO 13485 or in the aerospace industry can be offered exclusively with customer-specific, individual agreements by SCHURTER.

## Approvals







The approval mark is used by the testing authorities to certify compliance with the safety requirements placed on electronic products.

Approval Reference Type: 5124

Approval Logo	Certificates	Certification Body	Description
	VDE Approvals	VDE	Certificate Number: 40016382
	UL Approvals	UL	UR File Number: E495089
	CQC Approvals	CQC	CQC Certificate Number: CQC20001259802



## Product standards

Product standards that are referenced

Organization	Design	Standard	Description
	Designed according to	IEC 60320-1	Appliance couplers for household and similar general purposes
	Designed according to	IEC 60939	Passive filters for suppressing electromagnetic interference
	Designed according to	UL 498	Standard for Attachment Plugs and Receptacles
	Designed according to	UL 60939-3	Electromagnetic interference filters
	Designed according to	CSA C22.2 no. 42	General Use Receptacles, Attachment Plugs, and Similar Wiring Devices
	Designed according to	CSA C22.2 no. 8	Electromagnetic interference (EMI) filters







## Application standards

Application standards where the product can be used

Organization	Design	Standard	Description
	Suitable for applications acc.	IEC/UL 62368-1	Audio/video, information and communication technology equipment - Part 1: Safety requirements
	Suitable for applications acc.	IEC 60601-1	Medical electrical equipment - Part 1: General requirements for basic safety and essential performance

## Compliances

The product complies with following Guide Lines

Identification	Details	Initiator	Description
	CE declaration of conformity	SCHURTER AG	The CE marking declares that the product complies with the applicable requirements laid down in the harmonisation of Community legislation on its affixing in accordance with EU Regulation 765/2008.
	UKCA declaration of conformity	SCHURTER AG	The UKCA marking declares that the product complies with the applicable requirements laid down in the British Amendment of Regulation (EC) 765/2008.
	RoHS	SCHURTER AG	Directive RoHS 2011/65/EU, Amendment (EU) 2015/863
	China RoHS	SCHURTER AG	The law SJ / T 11363-2006 (China RoHS) has been in force since 1 March 2007. It is similar to the EU directive RoHS.
	REACH	SCHURTER AG	On 1 June 2007, Regulation (EC) No 1907/2006 on the Registration, Evaluation, Authorization and Restriction of Chemicals 1 (abbreviated as "REACH") entered into force.
		SCHURTER AG	V-Lock system are based on a matching plug-dose combination. The connector is equipped with a notch intended for use with the latching cordset. The cord latching system prevents against accidental removal of the cordset.
	Medical Equipment	SCHURTER AG	Suitable for use in medical equipment according to IEC/UL 60601-1 (1 MOOP, 1 MOPP)

**Dimensions [mm]**

Front side mounting with plastic flange

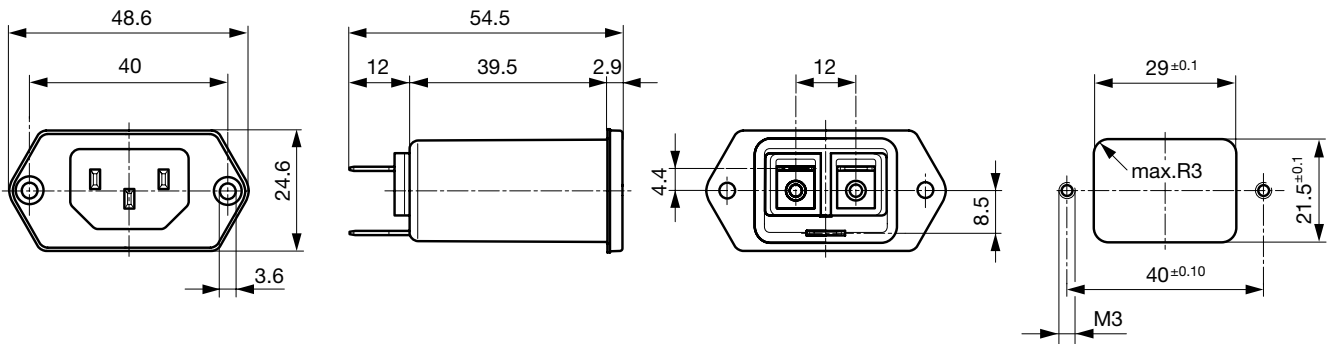

Snap-in mounting from front side

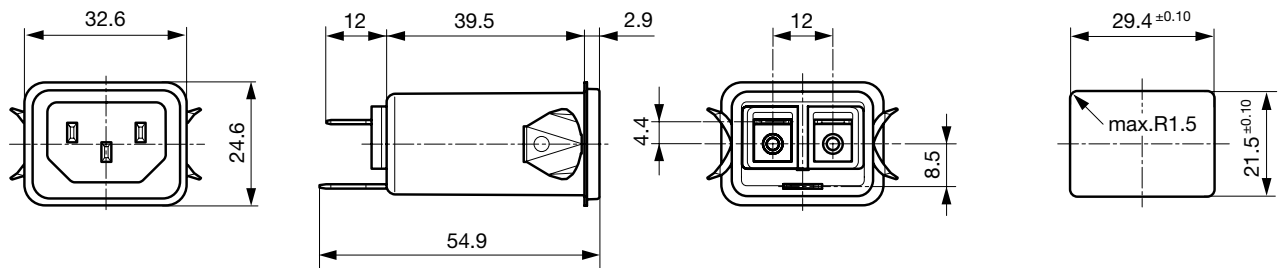

Dimensions for class I version also apply class II

**Technical Data of Filter-Components**

Rated Current [A]	Filter-Type	Inductances L [mH]	Capacitance CX [nF]	Capacitance CY [nF]	R [MΩ]
1	Standard version	2 x 89	220	2.2	1
2	Standard version	2 x 33	220	2.2	1
4	Standard version	2x 8.7	220	2.2	1
6	Standard version	2x 4.7	220	2.2	1
10	Standard version	2 x 1.5	220	2.2	1
15	Standard version	2 x 0.6	220	2.2	1
1	Medical Version (M5)	2 x 89	220	-	1
2	Medical Version (M5)	2 x 33	220	-	1
4	Medical Version (M5)	2x 8.7	220	-	1
6	Medical Version (M5)	2x 4.7	220	-	1
10	Medical Version (M5)	2 x 1.5	220	-	1
15	Medical Version (M5)	2 x 0.6	220	-	1

Diagrams

Standard version / Medical version M80

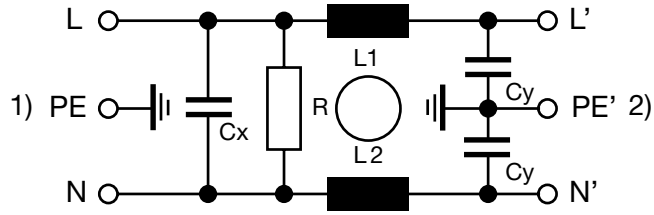

1) Line  
 2) Load

Medical Version (M5)

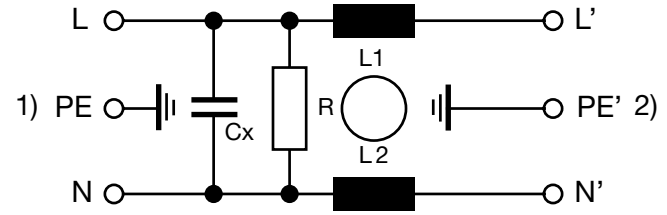

1) Line  
 2) Load

Attenuation Loss

--- 50Ω differential mode    \_\_\_\_ 50Ω common mode

Standard version

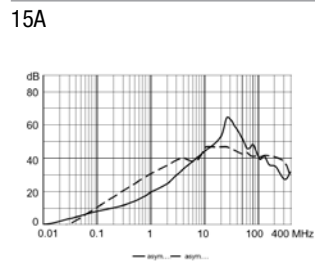
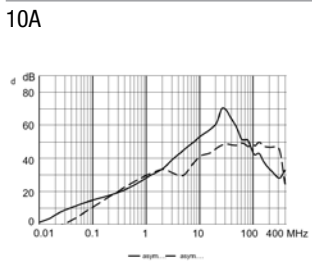
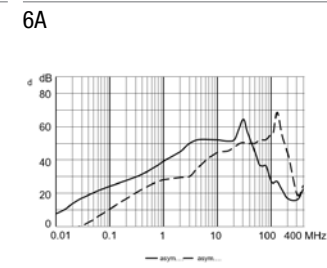
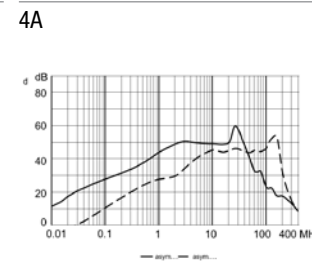
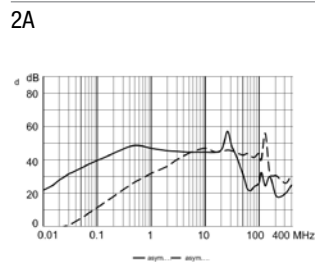
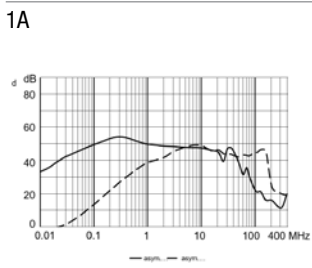

Medical version (M5)

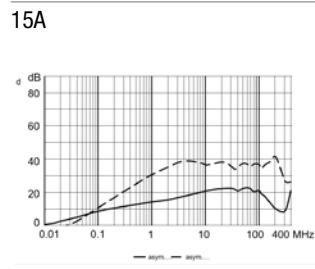
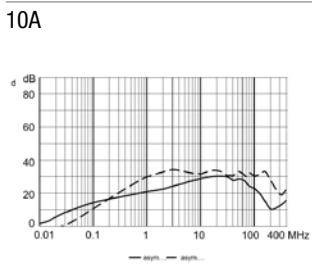
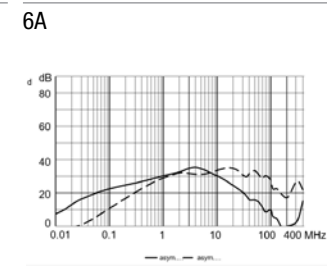
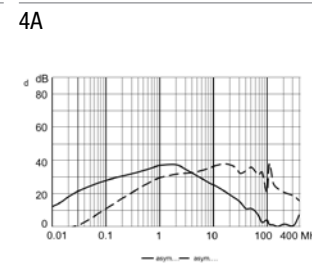
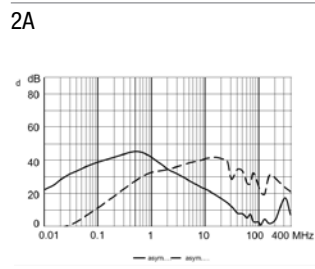
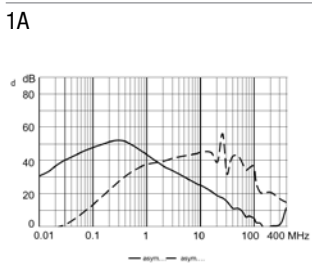

All Variants

Rated Current [A]	Filter-Type	Mounting	Mounting side	Terminal	Protection Class	V-Lock	Order Number
1	Standard version	Snap-in	front side	Quick connect terminals 6.3 x 0.8 mm	I	●	3-130-941
2	Standard version	Snap-in	front side	Quick connect terminals 6.3 x 0.8 mm	I	●	3-130-962
4	Standard version	Snap-in	front side	Quick connect terminals 6.3 x 0.8 mm	I	●	3-130-963
6	Standard version	Snap-in	front side	Quick connect terminals 6.3 x 0.8 mm	I	●	3-130-964
10	Standard version	Snap-in	front side	Quick connect terminals 6.3 x 0.8 mm	I	●	3-130-965
15	Standard version	Snap-in	front side	Quick connect terminals 6.3 x 0.8 mm	I	●	3-130-966
1	Standard version	Screw	front side	Quick connect terminals 6.3 x 0.8 mm	I	●	3-121-370
2	Standard version	Screw	front side	Quick connect terminals 6.3 x 0.8 mm	I	●	3-130-953
4	Standard version	Screw	front side	Quick connect terminals 6.3 x 0.8 mm	I	●	3-130-954
6	Standard version	Screw	front side	Quick connect terminals 6.3 x 0.8 mm	I	●	3-130-955
10	Standard version	Screw	front side	Quick connect terminals 6.3 x 0.8 mm	I	●	3-130-956
15	Standard version	Screw	front side	Quick connect terminals 6.3 x 0.8 mm	I	●	3-121-378
1	Medical Version (M5)	Snap-in	front side	Quick connect terminals 6.3 x 0.8 mm	I	●	3-130-967
2	Medical Version (M5)	Snap-in	front side	Quick connect terminals 6.3 x 0.8 mm	I	●	3-130-968
4	Medical Version (M5)	Snap-in	front side	Quick connect terminals 6.3 x 0.8 mm	I	●	3-130-969
6	Medical Version (M5)	Snap-in	front side	Quick connect terminals 6.3 x 0.8 mm	I	●	3-130-970
10	Medical Version (M5)	Snap-in	front side	Quick connect terminals 6.3 x 0.8 mm	I	●	3-130-971
15	Medical Version (M5)	Snap-in	front side	Quick connect terminals 6.3 x 0.8 mm	I	●	3-130-972
1	Medical Version (M5)	Screw	front side	Quick connect terminals 6.3 x 0.8 mm	I	●	3-130-935
2	Medical Version (M5)	Screw	front side	Quick connect terminals 6.3 x 0.8 mm	I	●	3-130-936
4	Medical Version (M5)	Screw	front side	Quick connect terminals 6.3 x 0.8 mm	I	●	3-130-937
6	Medical Version (M5)	Screw	front side	Quick connect terminals 6.3 x 0.8 mm	I	●	3-130-938
10	Medical Version (M5)	Screw	front side	Quick connect terminals 6.3 x 0.8 mm	I	●	3-130-939
15	Medical Version (M5)	Screw	front side	Quick connect terminals 6.3 x 0.8 mm	I	●	3-130-940

Most Popular.

Availability for all products can be searched real-time: <https://www.schurter.com/en/Stock-Check/Stock-Check-SCHURTER>

Rated Current [A]	Filter-Type	Mounting	Mounting side	Terminal	Protection Class	V-Lock	Order Number
-------------------	-------------	----------	---------------	----------	------------------	--------	--------------

- 15 A version only according UL/CSA

<b>Packaging unit</b>	10 Pcs
-----------------------	--------

**Accessories**

**Description**



[Wire\\_Harness](#)  
 Wire harness for SCHURTER products

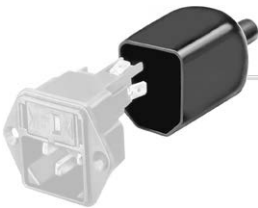

[Assorted\\_Covers](#)  
 Rear Cover

0859.0048



[RC320](#)  
 Rear Cover for Power Entry Module

3-125-664



[Cord\\_retaining\\_kits](#)  
 Cord retaining strain relief

**Mating Outlets/Connectors**

**Category / Description**

[Appliance Outlet Overview complete](#)



4787, Mounting: Screw-on mounting, Appliance Outlet: IEC Solder terminals, 10 A, Suitable for appliances with protection class I	4787
4788, Mounting: Snap-in version, Appliance Outlet: IEC Solder / Quick Connect, 10 A, Suitable for appliances with protection class I	4788
IEC Appliance Outlet F or H, Screw-on Mounting, Front Side, Solder, PCB or Quick-connect Terminal	5091

[Connector Overview complete](#)



4782 Mounting: Power Cord, 3 x 1 mm <sup>2</sup> / 3 x 18 AWG, Cable, Connector: IEC C13	4782
4785 Mounting: Power Cord, 3 x 1 mm <sup>2</sup> / 3 x 18 AWG, Cable, Connector: IEC C13	4785
4300-06 Mounting: Power Cord, 3 x 1 mm <sup>2</sup> / 3 x 18 AWG, Cable, Connector: IEC C13	4300-06

**Mating Outlets/Connectors shuttered**

[Connector Overview complete](#)



4783 Mounting: Power Cord, 3 x 1 mm <sup>2</sup> / 3 x 18 AWG, Cable, Connector: IEC C13	4783
--	------

[Power Cord Overview complete](#)



VAC13KS, Overview, V-Lock cord retaining, diverse Connector IEC C13, diverse, black	VAC13KS
VAC17KS, V-Lock cord retaining, diverse m, Connector IEC C17, diverse, black / grey / white	VAC17KS