

IEC Appliance Inlet C20, Screw-on Mounting, Rear Side, PCB Terminal



See below:
[Approvals and Compliances](#)

Description

- Panel mount :
- Screw-on mounting , rear-side
- Appliance Inlet , Pin temperature 70 °C , Protection class I
- For PCB mounting

Weblinks

[pdf data sheet](#), [html datasheet](#), [General Product Information](#), [Approvals](#), [Distributor-Stock-Check](#), [Accessories](#), [Detailed request for product](#)

Technical Data

Ratings IEC	16A / 250VAC; 50Hz	Appliance inlet/-outlet	C20 acc. to IEC 60320-1
Ratings UL/CSA	20A / 250VAC; 60Hz		UL 60320-1, CSA C22.2 no. 60320-1
Dielectric Strength	> 3 kVAC between L-N > 1.5 kVAC between L/N-PE (1 min/50Hz)		(for cold conditions) pin-temperature 70 °C, 16A, Protection Class I
Allowable Operation Temperature	-25 °C to 70 °C		
IP-Protection	front side IP20 acc. to IEC 60529		
Protection against electric shock	Suitable for appliances with protection class I acc. to IEC 61140		
Terminal	For PCB mounting Solder terminal in line with PIN-axis		
Material: Housing	Thermoplastic, black, UL 94V-0		

Approvals and Compliances

Detailed information on product approvals, code requirements, usage instructions and detailed test conditions can be looked up in [Details about Approvals](#)

SCHURTER products are designed for use in industrial environments. They have approvals from independent testing bodies according to national and international standards. Products with specific characteristics and requirements such as required in the automotive sector according to IATF 16949, medical technology according to ISO 13485 or in the aerospace industry can be offered exclusively with customer-specific, individual agreements by SCHURTER.

Approvals

The approval mark is used by the testing authorities to certify compliance with the safety requirements placed on electronic products.
 Approval Reference Type: 1601

Approval Logo	Certificates	Certification Body	Description
	VDE Approvals	VDE	Certificate Number: 40053259
	UL Approvals	UL	UR File Number: E96454
	CCC Approvals	CCC	CCC Certificate Number:

Product standards

Product standards that are referenced

Organization	Design	Standard	Description
	Designed according to	IEC 60320-1	Appliance couplers for household and similar general purposes
	Designed according to	UL 60320-1	Standard for Attachment Plugs and Receptacles
	Designed according to	CSA C22.2 no. 60320-1	General Use Receptacles, Attachment Plugs, and Similar Wiring Devices





Application standards

Application standards where the product can be used

Organization	Design	Standard	Description
	Suitable for applications acc.	IEC/UL 62368-1	Audio/video, information and communication technology equipment - Part 1: Safety requirements

Compliances

The product complies with following Guide Lines

Identification	Details	Initiator	Description
	CE declaration of conformity	SCHURTER AG	The CE marking declares that the product complies with the applicable requirements laid down in the harmonisation of Community legislation on its affixing in accordance with EU Regulation 765/2008.
	UKCA declaration of conformity	SCHURTER AG	The UKCA marking declares that the product complies with the applicable requirements laid down in the British Amendment of Regulation (EC) 765/2008.
	RoHS	SCHURTER AG	Directive RoHS 2011/65/EU, Amendment (EU) 2015/863
	China RoHS	SCHURTER AG	The law SJ / T 11363-2006 (China RoHS) has been in force since 1 March 2007. It is similar to the EU directive RoHS.
	REACH	SCHURTER AG	On 1 June 2007, Regulation (EC) No 1907/2006 on the Registration, Evaluation, Authorization and Restriction of Chemicals 1 (abbreviated as "REACH") entered into force.

Dimensions [mm]

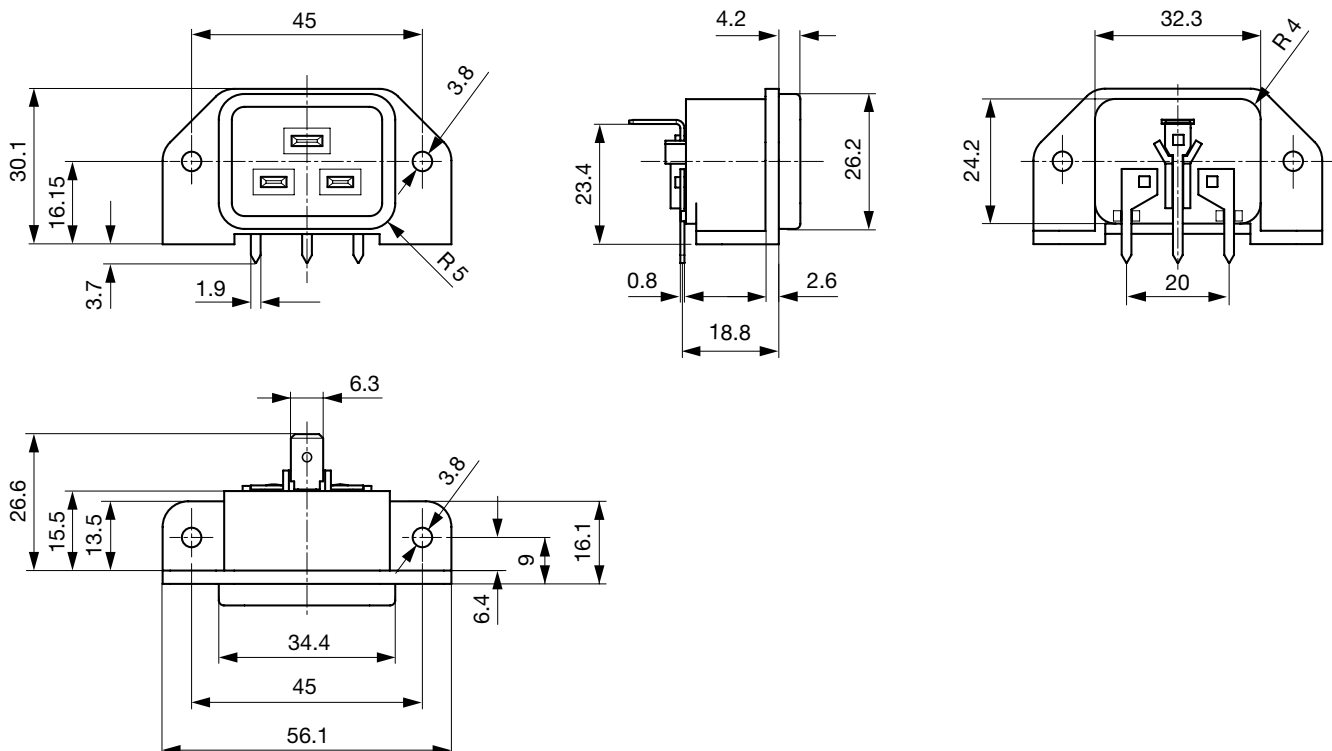

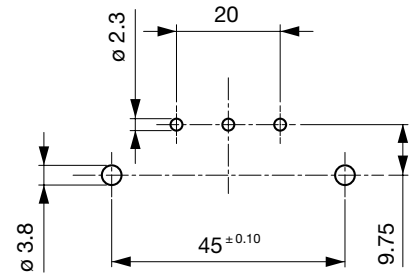
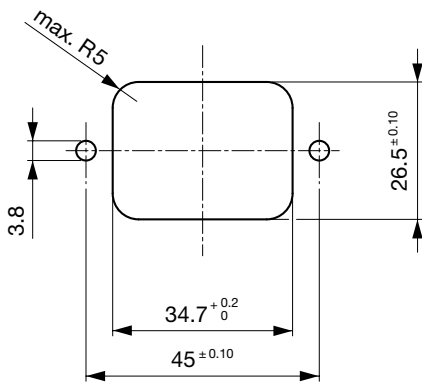

Panel cut-out and Drilling diagram

Config. Code

1601 - H - A B C 0 - D - E I

The characters are placeholders for the correspondingly keys of selections from the key tables.

1601 - H - A B C 0 - D - E I = Type

Type	Configuration key
protection class I	X

1601 - H - A B C 0 - D - E I = Terminals

Terminal L	Configuration key
PCB-terminal standard 	4

1601 - H - A B C 0 - D - E I = Terminals

Terminal N	Configuration key
PCB-terminal standard	4

Symbols similar as in table A

1601 - H - A B C 0 - D - E I = Terminals

Terminal Ground	Configuration key
PCB-terminal long (additional quick-connect terminal 6.3 x 0.8 mm)	6

Symbols similar as in table A

1601 - H - A B C 0 - D - E I = Color

Color	Configuration key
Black	A

1601 - H - A B C 0 - D - E I = Style

Style	Configuration key
flange with through holes	2

1601 - H - A B C 0 - D - E I = Additional Terminals

Additional Terminals	Configuration key
without additional terminal on L and N	0
additional quick connect terminal 6.3 x 0.8 mm on L and N	9

Variants

Terminals L / N	Terminal Ground	Color	Additional Terminals	Config. Code	Order Number
PCB-terminal standard	PCB-terminal long (additional quick-connect terminal 6.3 x 0.8 mm)	Black	additional quick connect terminal 6.3 x 0.8 mm on L and N	1601-X-4460-A-29	6163.0018
PCB-terminal standard	PCB-terminal long (additional quick-connect terminal 6.3 x 0.8 mm)	Black	without additional terminal on L and N	1601-X-4460-A-20	6163.0019

The listed variants should be available from stock. Other versions on request www.schurter.com/contact

Availability for all products can be searched real-time: <https://www.schurter.com/en/info-center/support-tools/stock-check-distributors>

Packaging unit

50 Pcs

Mating Outlets/Connectors

Category / Description

[Connector Overview complete](#)

4795, Mounting: Power Cord, Cable Connector: IEC C19	4795
4790, Mounting: Power Cord, Screw Connector: IEC C19	4790
0104U, Mounting: Power Supply Cord, Screw clamps Connector: IEC C19	0104U

[Power Supply Cord Overview complete](#)

Cord Sets 16 A, Europlug, 2.5 m, Connector IEC C19, H05VV-F3G1.5, black	6004.0395
Cord Sets 16 A, Interconnection, 1.0 m, Connector IEC C19, H05VV-F3G1.5, black	6020.0392
Cord Sets 16 A, Interconnection, 2.0 m, Connector IEC C19, H05VV-F3G1.5, black	6020.0394
Cord Sets 16 A, North America, 2.5 m, Connector IEC C19, SJT 3x14 AWG, black	6009.5195

Mating Outlets/Connectors shuttered

[Power Cord Overview complete](#)

VAC19KS, Overview, V-Lock cord retaining, diverse Connector IEC C19, diverse, black	VAC19KS
---	---------